

MODEL NO.	NAME	WEIGHT	ORIGINAL MODEL
	M24 RELIEF V/V	280g	708-25-14902 708-25-04311 (KOMATSU)
MAX PRESSURE	RATED FLOW	OPERATING TEMP	LEAKAGE
70kg/cm ²	40LPM	-30-90℃	600-900cc/min AT 15kg/cm ²

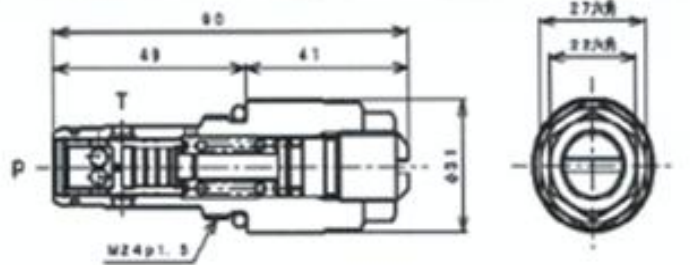

MODEL NO.	NAME	WEIGHT	ORIGINAL MODEL
	M24 RELIEF V/V	280g	708-2L-04312 708-1L-04310(KOMATSU)
MAX PRESSURE	RATED FLOW	OPERATING TEMP	LEAKAGE
70kg/cm ²	40LPM	-30-90℃	600-900cc/min AT 15kg/cm ²

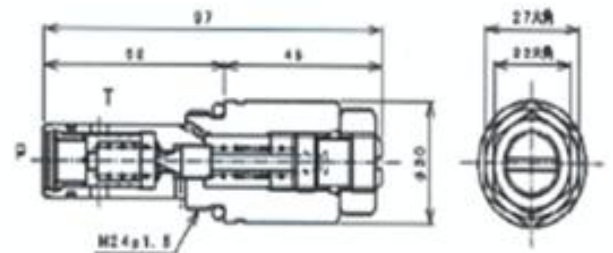

MODEL NO.	NAME	WEIGHT	ORIGINAL MODEL
	M24 RELIEF V/V	280g	709-70-55103 709-70-55300 (KOMATSU)
MAX PRESSURE	RATED FLOW	OPERATING TEMP	LEAKAGE
70kg/cm ²	30LPM	-30-90℃	40cc/min AT 11kg/cm ²

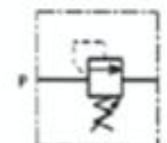
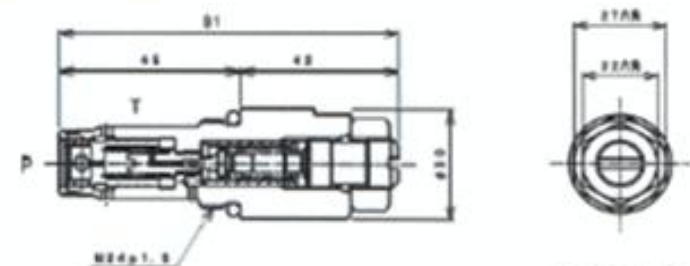

MODEL NO.	NAME	WEIGHT	ORIGINAL MODEL
	M24 RELIEF V/V	280g	709-20-52300 709-20-51800 (KOMATSU)
MAX PRESSURE	RATED FLOW	OPERATING TEMP	LEAKAGE
350kg/cm ²	40LPM	-30-90℃	100cc/min AT 100kg/cm ²

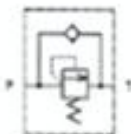
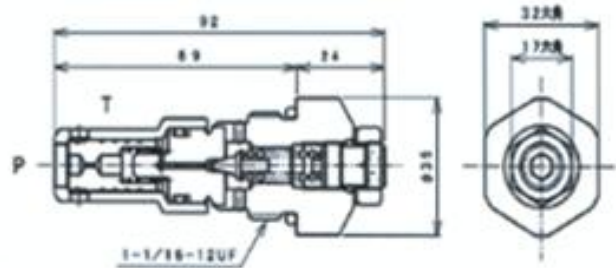

MODEL NO.	NAME	WEIGHT	ORIGINAL MODEL
	1-1/16 ANTI-C RELIEF V/V	230g	4242176 (HITACHI)
MAX PRESSURE	RATED FLOW	OPERATING TEMP	LEAKAGE
350kg/cm ²	50LPM	-30~90°C	100cc/min AT 100kg/cm ²

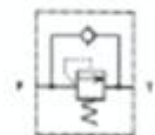
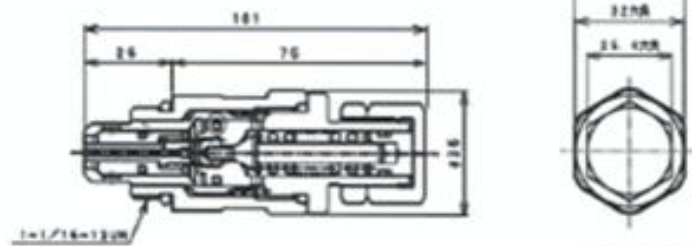

MODEL NO.	NAME	WEIGHT	ORIGINAL MODEL
	1-1/16 ANTI-C RELIEF V/V	230g	6E-2914 (CATERPILLA)
MAX PRESSURE	RATED FLOW	OPERATING TEMP	LEAKAGE
400kg/cm ²	50LPM	-30~90°C	100cc/min AT 100kg/cm ²

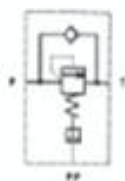
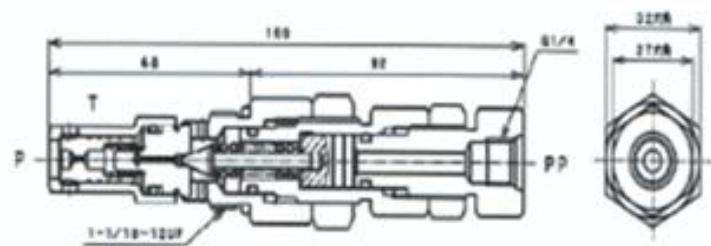

MODEL NO.	NAME	WEIGHT	ORIGINAL MODEL
	1-1/16 ANTI-C PILOT RELIEF V/V	320g	4372038 (HITACHI)
MAX PRESSURE	RATED FLOW	OPERATING TEMP	LEAKAGE
400kg/cm ²	50LPM	-30~90°C	100cc/min AT 100kg/cm ²

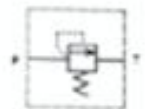
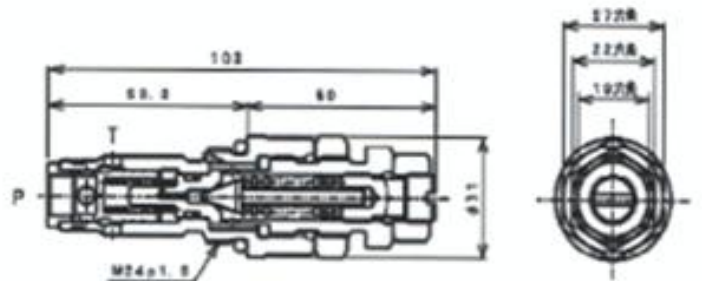

MODEL NO.	NAME	WEIGHT	ORIGINAL MODEL
	M24 RELIEF V/V	260g	723-40-50201 (KOMATSU)
MAX PRESSURE	RATED FLOW	OPERATING TEMP	LEAKAGE
350kg/cm ²	50LPM	-30~90°C	100cc/min AT 100kg/cm ²

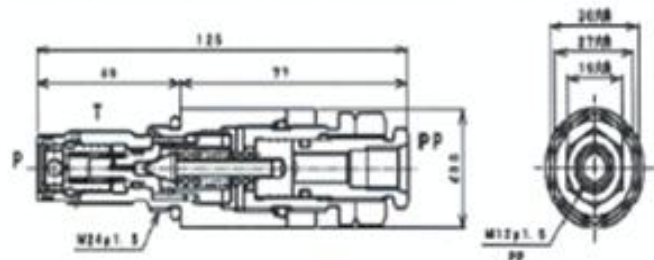

MODEL NO.	NAME	WEIGHT	ORIGINAL MODEL
	M24 PILOT RELIEF V/V	280g	723-40-51102 723-40-51201 (KOMATSU)
MAX PRESSURE	RATED FLOW	OPERATING TEMP	LEAKAGE
350kg/cm ²	50LPM	-30-90°C	100cc/min AT 100kg/cm ²

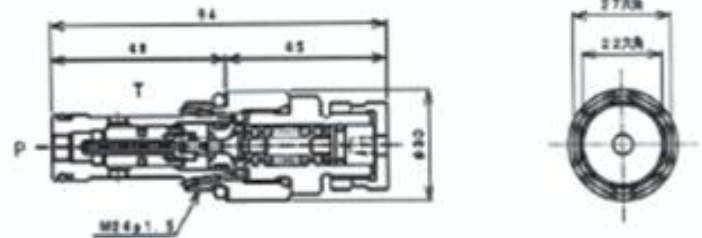

MODEL NO.	NAME	WEIGHT	ORIGINAL MODEL
	M24 RELIEF V/V	370g	723-20-61101 (KOMATSU)
MAX PRESSURE	RATED FLOW	OPERATING TEMP	LEAKAGE
350kg/cm ²	50LPM	-30-90°C	30cc/min AT 100kg/cm ²

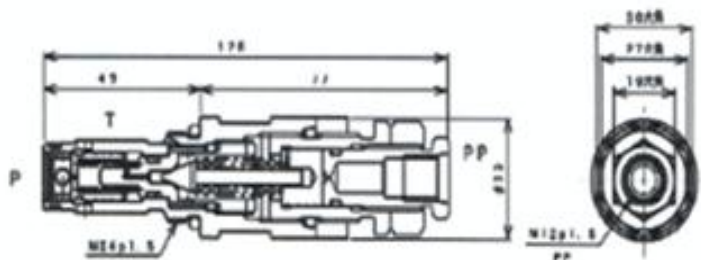

MODEL NO.	NAME	WEIGHT	ORIGINAL MODEL
	M24 PILOT RELIEF V/V	420g	723-40-51401 (KOMATSU)
MAX PRESSURE	RATED FLOW	OPERATING TEMP	LEAKAGE
350kg/cm ²	50LPM	-30-90°C	100cc/min AT 100kg/cm ²

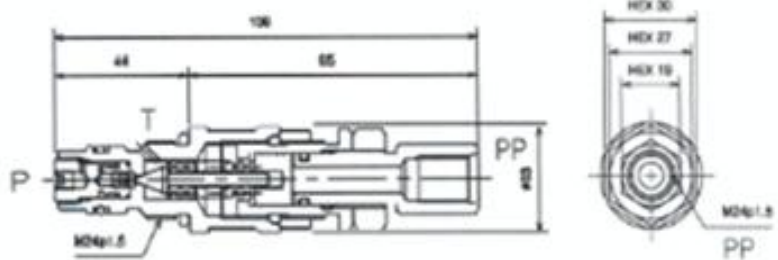

MODEL NO.	NAME	WEIGHT	ORIGINAL MODEL
	PILOT RELIEF V/V	420g	723-30-50101 (KOMATSU)
MAX PRESSURE	RATED FLOW	OPERATING TEMP	LEAKAGE
400kg/cm ²	50LPM	-30-90°C	30cc/min AT 100kg/cm ²

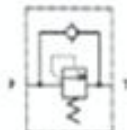
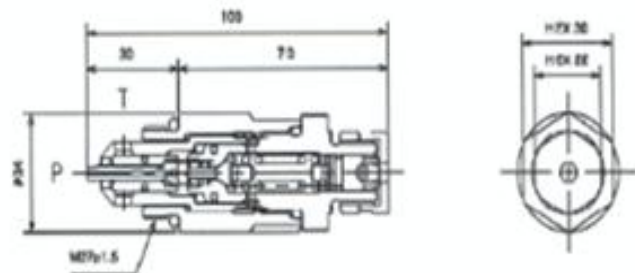

MODEL NO.	NAME	WEIGHT	ORIGINAL MODEL
-	M27 ANTI-C RELIEF V/V	650g	723-40-91300 (KOMATSU)
MAX PRESSURE	RATED FLOW	OPERATING TEMP	LEAKAGE
350kg/cm ²	80LPM	-30~90°C	100cc/min AT 100kg/cm ²

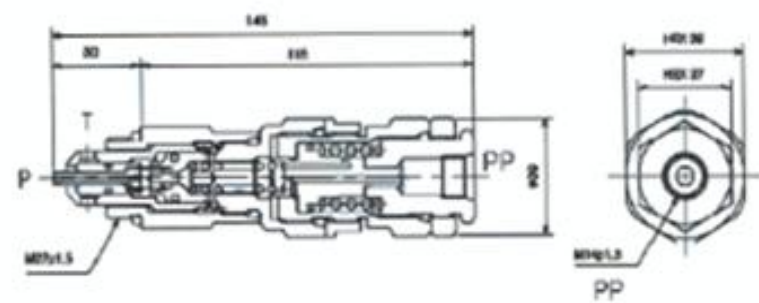

MODEL NO.	NAME	WEIGHT	ORIGINAL MODEL
-	M27 ANTI-C PILOT RELIEF	1.5Kg	723-40-90101 (KOMATSU)
MAX PRESSURE	RATED FLOW	OPERATING TEMP	LEAKAGE
400kg/cm ²	80LPM	-30~90°C	100cc/min AT 100kg/cm ²

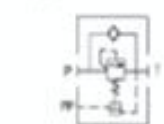
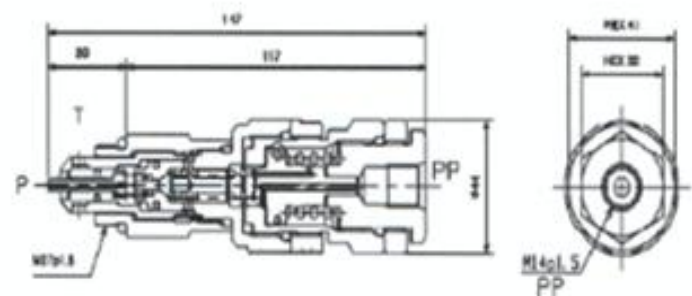

MODEL NO.	NAME	WEIGHT	ORIGINAL MODEL
-	M27 ANTI-C PILOT RELIEF	1.5Kg	723-90-76101 (KOMATSU)
MAX PRESSURE	RATED FLOW	OPERATING TEMP	LEAKAGE
350kg/cm ²	80LPM	-30~90°C	100cc/min AT 100kg/cm ²

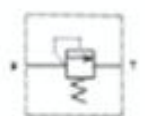
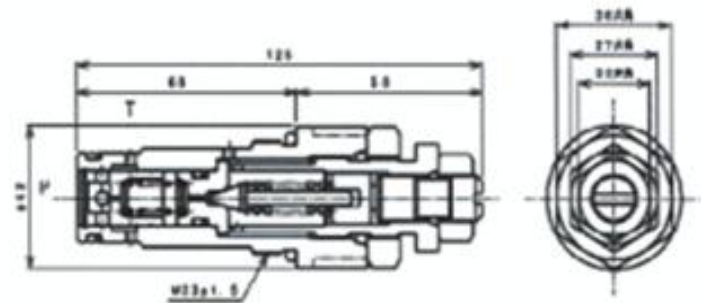

MODEL NO.	NAME	WEIGHT	ORIGINAL MODEL
-	M33 RELIEF V/V	680g	709-70-51200, 709-80-52600 (KOMATSU)
MAX PRESSURE	RATED FLOW	OPERATING TEMP	LEAKAGE
350kg/cm ²	80LPM	-30~90°C	100cc/min AT 100kg/cm ²

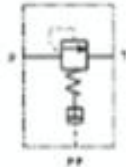
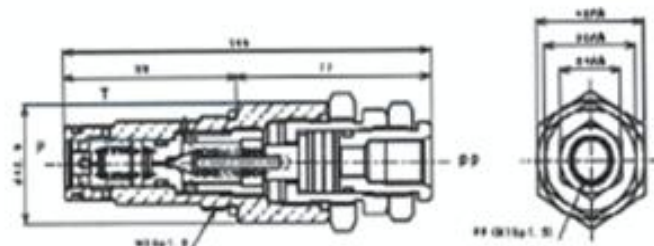

MODEL NO.	NAME	WEIGHT	ORIGINAL MODEL
	M33 PILOT RELIEF V/V	800g	709-70-51401 723-30-90101 (KOMATSU)
MAX PRESSURE	RATED FLOW	OPERATING TEMP	LEAKAGE
350kg/cm ²	80LPM	-30~90°C	100cc/min AT 100kg/cm ²

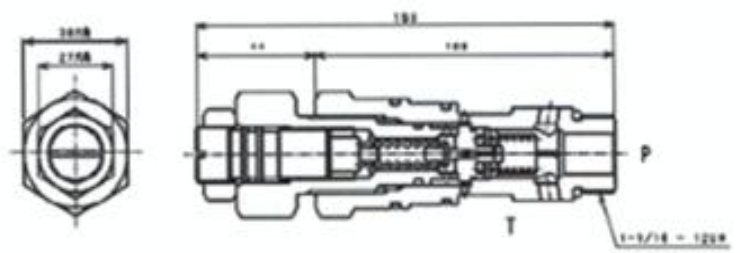

MODEL NO.	NAME	WEIGHT	ORIGINAL MODEL
	1-1/16 RELIEF V/V	860g	6E-5933 (CATERPILLA)
MAX PRESSURE	RATED FLOW	OPERATING TEMP	LEAKAGE
350kg/cm ²	80LPM	-30~90°C	100cc/min AT 100kg/cm ²

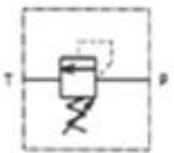
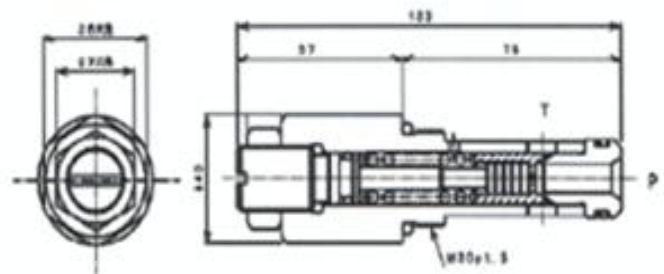

MODEL NO.	NAME	WEIGHT	ORIGINAL MODEL
	M30 RELIEF V/V	660g	702-75-01201 (KOMATSU)
MAX PRESSURE	RATED FLOW	OPERATING TEMP	LEAKAGE
350kg/cm ²	80LPM	-30~90°C	100cc/min AT 100kg/cm ²

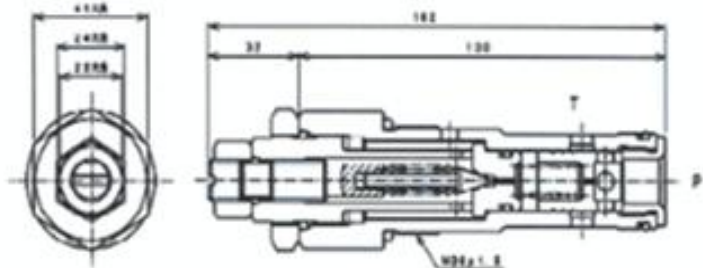

MODEL NO.	NAME	WEIGHT	ORIGINAL MODEL
	M36 RELIEF V/V	980g	709-90-51100 (KOMATSU)
MAX PRESSURE	RATED FLOW	OPERATING TEMP	LEAKAGE
350kg/cm ²	80LPM	-30~90°C	100cc/min AT 100kg/cm ²

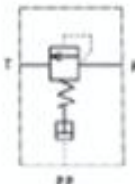
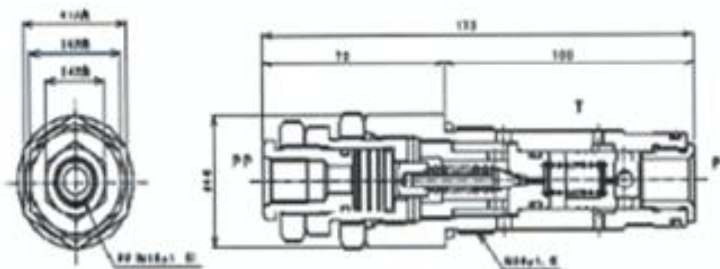

MODEL NO.	NAME	WEIGHT	ORIGINAL MODEL
	M36 PILOT RELIEF V/V	1.1kg	709-90-52203 (KOMATSU)
MAX PRESSURE	RATED FLOW	OPERATING TEMP	LEAKAGE
350kg/cm ²	80LPM	-30~90°C	100cc/min AT 100kg/cm ²

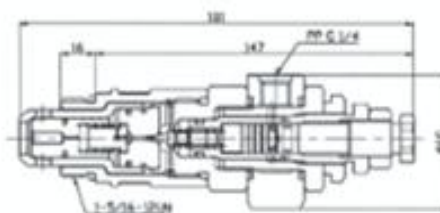

MODEL NO.	NAME	WEIGHT	ORIGINAL MODEL
	1-5/16 PILOT RELIEF V/V	1.2 kg	21113-50306
MAX PRESSURE	RATED FLOW	OPERATING TEMP	LEAKAGE
350kg/cm ²	80LPM	-30~90°C	30cc/min AT 100kg/cm ²

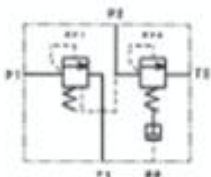
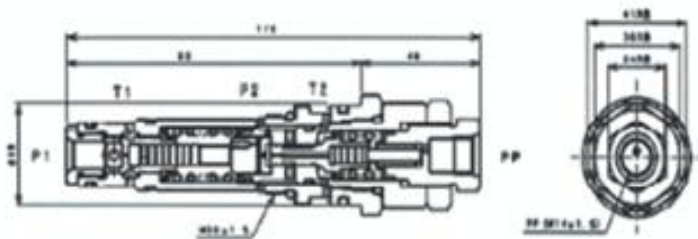

MODEL NO.	NAME	WEIGHT	ORIGINAL MODEL
	M30 PILOT RELIEF V/V	1.3kg	723-40-50100 (KOMATSU)
MAX PRESSURE	RATED FLOW	OPERATING TEMP	LEAKAGE
350kg/cm ²	50LPM	-30~90°C	15cc/min AT 100kg/cm ²

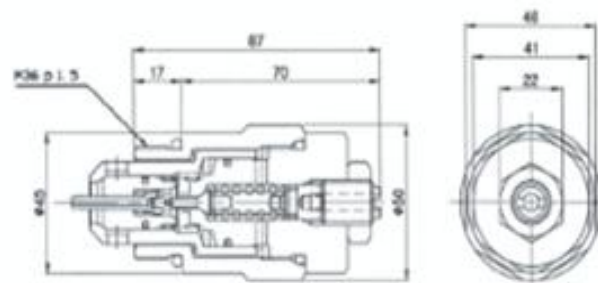

MODEL NO.	NAME	WEIGHT	ORIGINAL MODEL
	M36 RELIEF V/V	1.2 kg	709-90-73100 (KOMATSU)
MAX PRESSURE	RATED FLOW	OPERATING TEMP	LEAKAGE
350kg/cm ²	80LPM	-30~90°C	30cc/min AT 100kg/cm ²

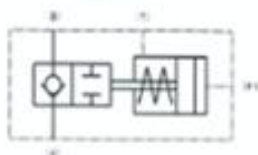
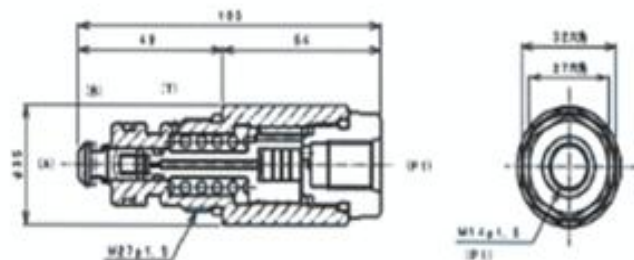

MODEL NO.	NAME	WEIGHT	ORIGINAL MODEL
	VALVE ASS'Y	428g	723-40-60101 723-30-60101 (KOMATSU)
MAX PRESSURE	RATED FLOW	OPERATING TEMP	LEAKAGE
350kg/cm ²	50LPM	-30~90°C	30cc/min AT 100kg/cm ²

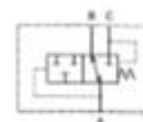
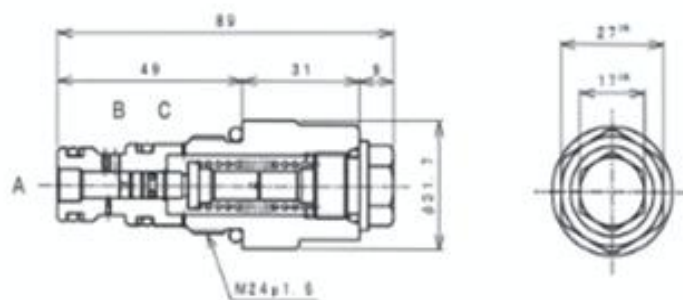

MODEL NO.	NAME	WEIGHT	ORIGINAL MODEL
	UNLOAD V/V	178g	723-30-56100 (KOMATSU)
MAX PRESSURE	RATED FLOW	OPERATING TEMP	LEAKAGE
70kg/cm ²	30LPM	-30~90°C	5cc/min AT 20kg/cm ²

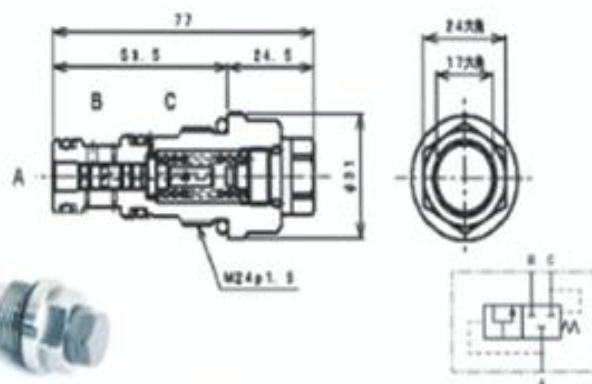

MODEL NO.	NAME	WEIGHT	ORIGINAL MODEL
	UNLOAD V/V	178g	723-40-56100 723-40-56302 723-40-56600 (KOMATSU)
MAX PRESSURE	RATED FLOW	OPERATING TEMP	LEAKAGE
70kg/cm ²	30LPM	-30~90°C	5cc/min AT 30kg/cm ²

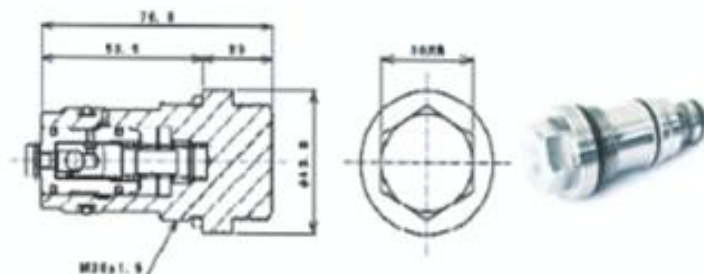

MODEL NO.	NAME	WEIGHT	ORIGINAL MODEL
	CONTROL V/V	230g	723-46-45100 723-46-41100 723-46-40100 723-46-46300 (KOMATSU)
MAX PRESSURE	RATED FLOW	OPERATING TEMP	LEAKAGE
		-30~90°C	3cc/min AT 50kg/cm ²

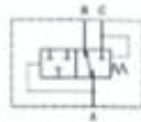
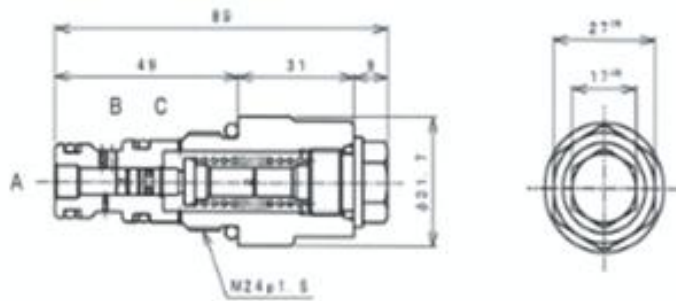

MODEL NO.	NAME	WEIGHT	ORIGINAL MODEL
	UNLOAD V/V	178g	723-30-56100 (KOMATSU)
MAX PRESSURE	RATED FLOW	OPERATING TEMP	LEAKAGE
70kg/cm ²	30LPM	-30~90℃	5cc/min AT 20kg/cm ²

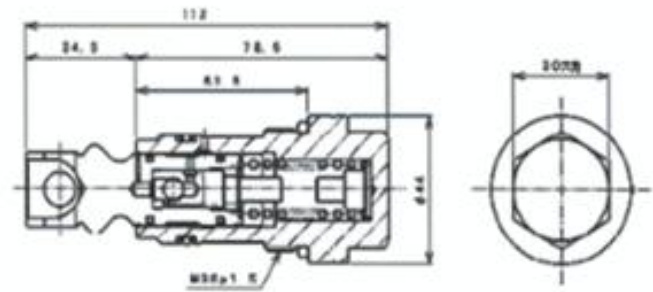

MODEL NO.	NAME	WEIGHT	ORIGINAL MODEL
	CONTROL V/V	280g	723-46-43200 (KOMATSU)
MAX PRESSURE	RATED FLOW	OPERATING TEMP	LEAKAGE
		-30~90℃	3cc/min AT 50kg/cm ²

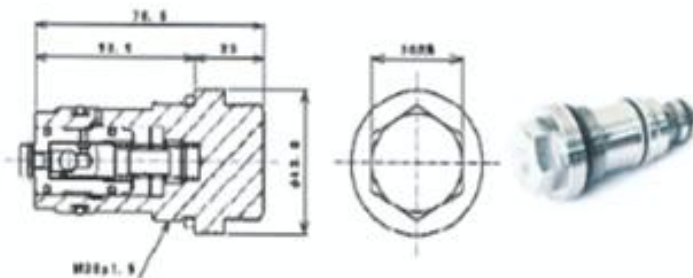

MODEL NO.	NAME	WEIGHT	ORIGINAL MODEL
	CONTROL V/V	230g	723-46-45100 723-46-41100 723-46-40100 723-46-46300 (KOMATSU)
MAX PRESSURE	RATED FLOW	OPERATING TEMP	LEAKAGE
		-30~90℃	3cc/min AT 50kg/cm ²

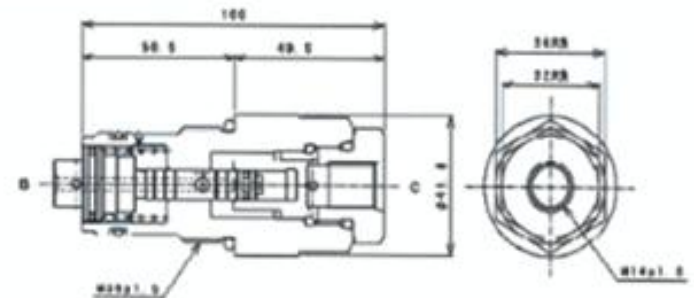

MODEL NO.	NAME	WEIGHT	ORIGINAL MODEL
	CONTROL V/V	350g	723-46-40702 (KOMATSU)
MAX PRESSURE	RATED FLOW	OPERATING TEMP	LEAKAGE
		-30~90℃	3cc/min AT 50kg/cm ²

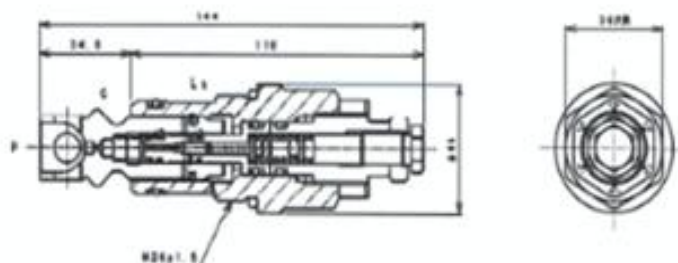

MODEL NO.	NAME	WEIGHT	ORIGINAL MODEL
	CONTROL V/V	460g	723-46-48100 (KOMATSU)
MAX PRESSURE	RATED FLOW	OPERATING TEMP	LEAKAGE
		-30~90℃	

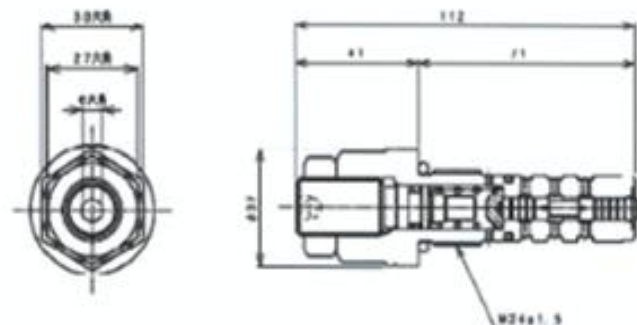

MODEL NO.	NAME	WEIGHT	ORIGINAL MODEL
	V/V ASS'Y	1.1kg	708-1W-04712 (KOMATSU)
MAX PRESSURE	RATED FLOW	OPERATING TEMP	LEAKAGE
		-30~90℃	

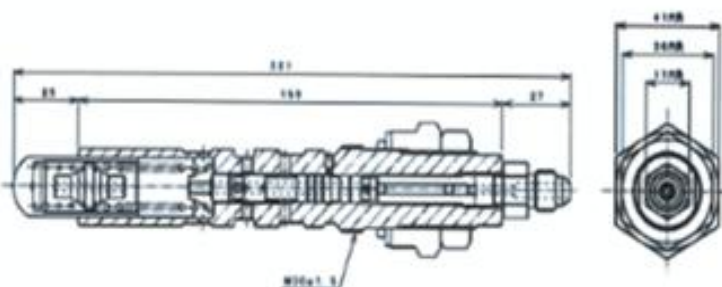

MODEL NO.	NAME	WEIGHT	ORIGINAL MODEL
	PC SERVO A.	1.5kg	708-1W-04612 708-1W-04512 (KOMATSU)
MAX PRESSURE	RATED FLOW	OPERATING TEMP	LEAKAGE
		-30~90℃	

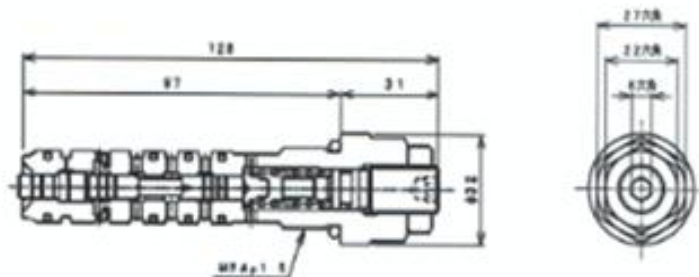

MODEL NO.	NAME	WEIGHT	ORIGINAL MODEL
	V/V ASS'Y	1.2kg	708-2L-06710 (KOMATSU)
MAX PRESSURE	RATED FLOW	OPERATING TEMP	LEAKAGE
		-30~90℃	

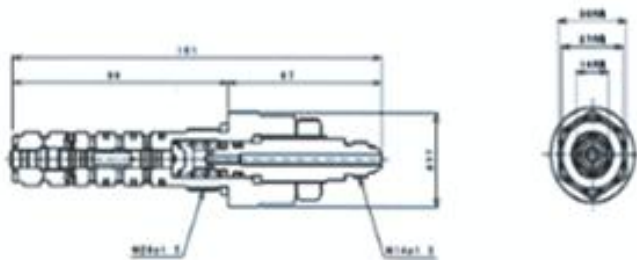

MODEL NO.	NAME	WEIGHT	ORIGINAL MODEL
	V/V ASS'Y LS	1.3kg	708-2L-04713 708-1L-04720 (KOMATSU)
MAX PRESSURE	RATED FLOW	OPERATING TEMP	LEAKAGE
		-30~90℃	

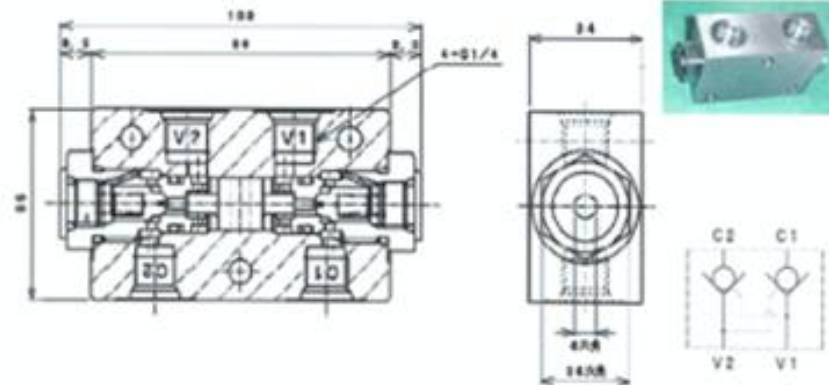

MODEL NO.	NAME	WEIGHT	ORIGINAL MODEL
	1/4 Pilot Check V/V	1.2kg	DPCV-02T-00
MAX PRESSURE	RATED FLOW	OPERATING TEMP	LEAKAGE
250kg/cm ²	20LPM PILOT RATIO : 6.25	-30~90℃	0.05cc/min

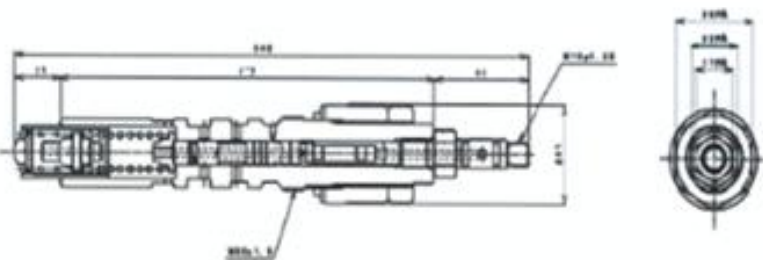

MODEL NO.	NAME	WEIGHT	ORIGINAL MODEL
	V/V ASS'Y	1.6kg	708-1L-04615 708-2L-04523 (KOMATSU)
MAX PRESSURE	RATED FLOW	OPERATING TEMP	LEAKAGE
		-30~90℃	

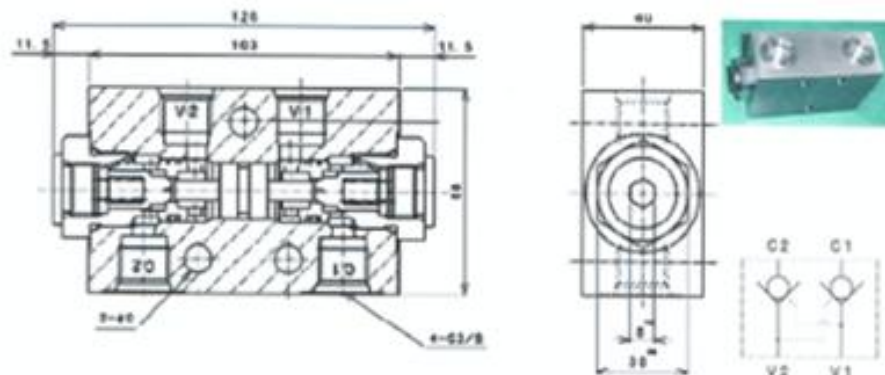

MODEL NO.	NAME	WEIGHT	ORIGINAL MODEL
	3/8 Pilot Check V/V	2.1kg	DPCV-03T-00
MAX PRESSURE	RATED FLOW	OPERATING TEMP	LEAKAGE
250kg/cm ²	30LPM PILOT RATIO : 5.6	-30~90℃	0.05cc/min

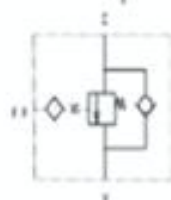
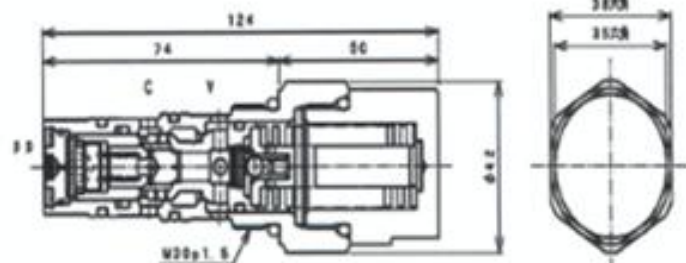

MODEL NO.	NAME	WEIGHT	ORIGINAL MODEL
	30CR COUNT BALANCE	860g	CBV-30CRB-S3-12
MAX PRESSURE	RATED FLOW	OPERATING TEMP	LEAKAGE
210kg/cm ²	30~50LPM	-30~90℃	0.1cc/min AT 210kg/cm ²